









# CONTENTS

SECTION 1 - INTRODUCTION .....	2
SECTION 2 - INSTALLATION .....	3
2.1 - SM DUE Unit .....	4
2.2 - Sensors .....	4
2.3 - Alarm Relay .....	5
2.4 - Power Connections and Wiring Diagram .....	5
2.5 - Battery .....	5
SECTION 3 - OPERATION .....	6
3.1 - DESCRIPTION .....	6
3.2 - MAIN SCREENS: 	
3.2.1 MAIN SCREEN 1: Channel Temperature Display .....	8
3.2.2 MAIN SCREEN 2: Current Day Plot Screen .....	9
3.3 - SET SCREENS: 	
3.3.1 SET SCREEN 1: Clock / Calendar .....	10
3.3.2 SET SCREEN 2: System Pre-sets 1.....	11
3.3.3 SET SCREEN 3: System Pre-sets 2 .....	13
3.4 - SYSTEM DIAGNOSTICS: 	
3.4.1 DATABANK DIAGNOSTICS SCREEN .....	14
3.4.2 CHANNEL DIAGNOSTICS SCREEN .....	15
3.4.3 CALIBRATION TRIMMING SCREEN .....	16
3.5 - CHANNEL SCREENS:  / 	
3.5.1 CHANNEL DISPLAY SCREENS .....	17
3.5.2 CHANNEL SET SCREENS .....	18
3.6 - PLOT HISTORY : 	
3.6.1 Data log of previous days .....	19
3.7 - DATA TRANSFER: 	20
3.7.1 Transferring Data Using the Masterlink Software .....	20
3.7.2 Transferring Data to the Masterlink Hardware .....	20
3.7.3 Printing Data to the Thermomax Serial Printer .....	22
3.8 - DATA TRANSFER - PANELMOUNT UNITS ONLY .....	23
SECTION 4 - FAULT FINDING .....	27
SECTION 5 - SPECIFICATIONS .....	28
KEYPAD LOCK .....	29
SM DUE PANELMOUNT .....	30

## SECTION 1 INTRODUCTION

The SM DUE microprocessor-based datalogger uses the novel approach of a paperless logging and filing system, which allows the data of any day in its history to be read and examined with a few key presses.

The large graphics LCD display communicates the information to the user with clarity, making programming and setting up friendly and uncomplicated, without compromising its sophistication and digital accuracy.

### SUMMARY OF FEATURES

#### DATALOGGER

- Paperless datalogger with automatic filing by date
- 50-year clock / calendar for datalogger filing.
- The temperature from each Channel is sampled every 5 minutes and stored to an internal databank.
- 'Percentage of internal databank used' indication in bargraph and digital form.
- Once the databank is 100% full, the first eighth of the stored data will automatically be replaced. (For the capacity of the databank, see Section 5).
- Power Supply options of either Mains or DC.
- Contents of internal databank can be transferred directly to the PC using the MASTERLINK Software or via a MASTERLINK Hardware module to a PC at a remote site.

#### ALARM

- 2-Stage high and low level alarms with mute and reset facilities,
- Stage 1 temperature threshold with trigger delay.
- Stage 2 limit temperature with immediate trigger.
- Diagnostics screen revealing system parameters.
- Alarm history record for low alarm, high alarm and power fail.
- Battery back-up for power-fail operation.

Note: The information supplied in this manual is for guidance only - no part of this may be used for any agreement, whether express or implied, or to form any contract.

## SECTION 2 INSTALLATION

Note: This installation procedure is for guidance only, and its suitability should be verified by the installer.

### SAFETY PRECAUTIONS

1. Before attempting to install and operate the unit, read this instruction manual carefully.
2. Installation and any maintenance required should only be carried out by suitably qualified personnel.
3. It is recommended that the unit be connected to the mains supply via a suitably rated isolating switch.
4. **WARNING: When the unit is connected to the mains supply and the cover is opened, circuits at mains voltage will be exposed.** Therefore when installing the unit, ensure all required connections (including battery connection, if included), are made and covers replaced before turning on the mains supply. Ensure that all the connections made are secure. If any maintenance work is required e.g. installing a new battery, ensure that the unit is isolated from the mains supply before removing the cover. **Never leave the unit unattended if the cover has been removed and the mains supply is connected.**
5. Do not exceed unit ratings as shown on the ratings label.
6. It is advisable to route mains cables away from low voltage or sensor cables.

## 2.1 SM DUE UNIT

NOTE: For viewing comfort, the SM DUE unit should be positioned at eye level. It is always good practice to keep electronic equipment away from cold, heat and electrical plant, as extremes of temperature may reduce the lifetime of the device, and heavy electrical loads, switches, relays or contactors too close to the device may cause electrical and electro-magnetic interference when switched on or off.

- 2.1.1 Knock out the entries into the moulding to be used for connection, either behind or under the moulding, whichever is suitable for the particular installation.
- 2.2.2 Fasten the screw corresponding to the top centre lug on the back of the SM DUE moulding, into the wall or panel on which the unit is to be mounted. Leave a gap of approximately 3mm between the screw head and the wall. Position the moulding and slot in the lug over the screw.
- 2.2.3 Level the SM DUE moulding and, if using rear entry, mark the entry holes in the panel behind the appropriate knock-out entries, as well as the two lower mounting holes.  
Remove the moulding, drill the necessary holes in the panel, assemble any grommets or conduit adapters if used, replace the moulding and fasten using the two lower screws.

## 2.2 SENSORS

Temperature sensors, SX™ PT100 are used with all Thermomax units. They are available in lengths from 5m to 100m, as are the sensor extenders, and all come with a 4-way telephone plug. Each sensor comes with an original Thermomax calibration certificate. The standard sensor can measure temperatures from +50°C / -50°C.

**Note:** Using suitable 3-core or 4-core cable, the sensor can be extended, according to the diagram shown below.

**Note:** In doing this, Thermomax calibration is removed.

The standard sensors PT100 are not suitable for use in acidic or alkaline environments and should not be used in fluids.



Please note however, that as with all PT100 sensor applications, a good connection is vital. It is therefore recommended that wherever there is any doubt, a factory- extended sensor or sensor extender should be used.

### 2.3 ALARM RELAY

NOTE: The alarm relay is a 3 contact changeover arrangement that is isolated (volt-free). This relay is normally energised, and switches off when the alarm is triggered, or in the case of power failure. It may be used to trigger an external bell, warning lamp, or digital communicator (telephone dialler).

If an external device is used connect the alarm as appropriate, according to the diagram in the next section.

### 2.4 POWER CONNECTIONS AND WIRING DIAGRAM

NOTE: This device should be properly earthed. Flexible wires simplify connection to the terminals. All connections should be secure and adequately tightened. It is good practice to keep mains cables away from sensor cables and other low voltage signal cables.

Connect the supply to the unit, as per diagram below, using the appropriate input voltage according to the application.

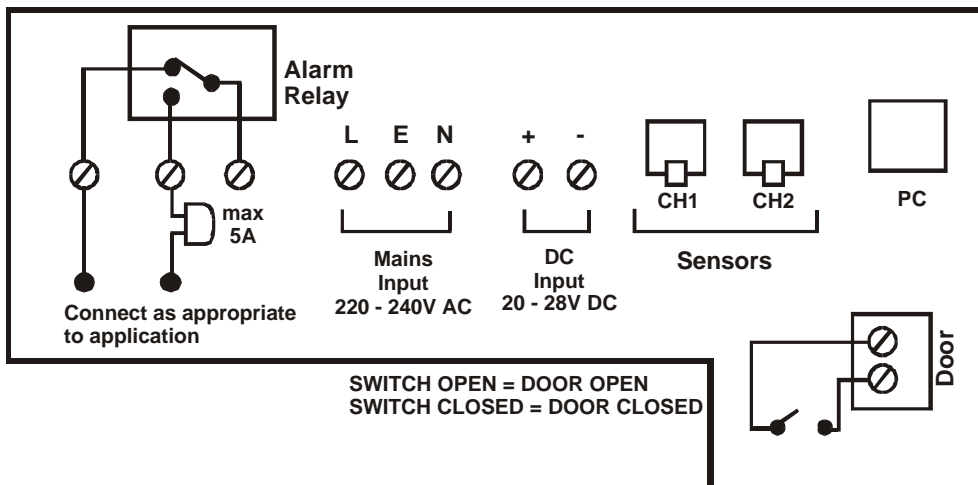

### 2.5 BATTERY

The battery supplied is a 9V PP3 nickel metal hydride rechargeable battery and is attached to the lid of the terminal compartment, but not plugged in. This should be plugged in after installation. This battery is not essential for the system operation, but is used in the case of power failure, thereby continuing to log the two input temperatures for 6 - 7 hours, and maintaining the system clock.

If the power cut takes longer and the battery is discharged, the clock must be set when the power supply is re-established. The system parameters remain intact.

It is recommended that the battery is changed every 12 months, in order to maintain good power failure operation. When replacing, ensure that the type of battery used is as specified - only a rechargeable PP3 battery should be used directly, as the battery is charged from the unit.

## SECTION 3 SM DUE OPERATION

In order to fully understand the operation of the SM DUE, this section should be read carefully.

### 3.1 DESCRIPTION

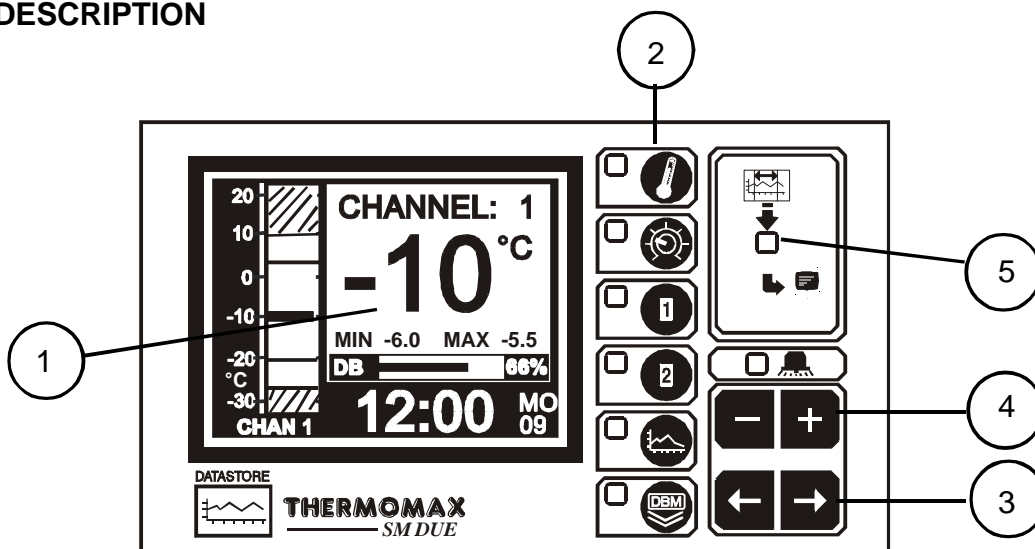







#### 1 GRAPHICS LCD DISPLAY



Displays all the information. The contrast is adjustable to suit the user. (See 3.2.1 Main Screen 1).

#### 2 FUNCTION KEYS

There are six function keys on the SM DUE datalogger:

- |   |  |   |  |
|---|--|---|--|
|  | - Main Screen 1<br>- Main Screen 2                   |  | - Channel 2 Display Screen<br>- Channel 2 Set Screen |
|  | - Set Screen 1<br>- Set Screen 2                     |  | - Plot History Screen                                |
|  | - Channel 1 Display Screen<br>- Channel 1 Set Screen |  | - Data Transfer Key                                  |

#### 3 SELECT KEYS

Within each function, there are some parameters that can be selected for setting or displaying purposes. The   keys allow the required parameter to be chosen, without changing any of its properties.

#### 4 SET KEYS

The **+** and **-** keys are used to set the value of any selected parameter, by increasing and decreasing the value respectively. In most of the functions, described later in the manual, the **+** and **-** keys have an auto-repeat facility: press and hold the key in order to advance quickly.

**Note:** The **+** and **-** keys are the only keys which can alter the value of a selected parameter. Other keys may be pressed to view or select these parameters without effecting any change in the system.

#### 5 INDICATORS

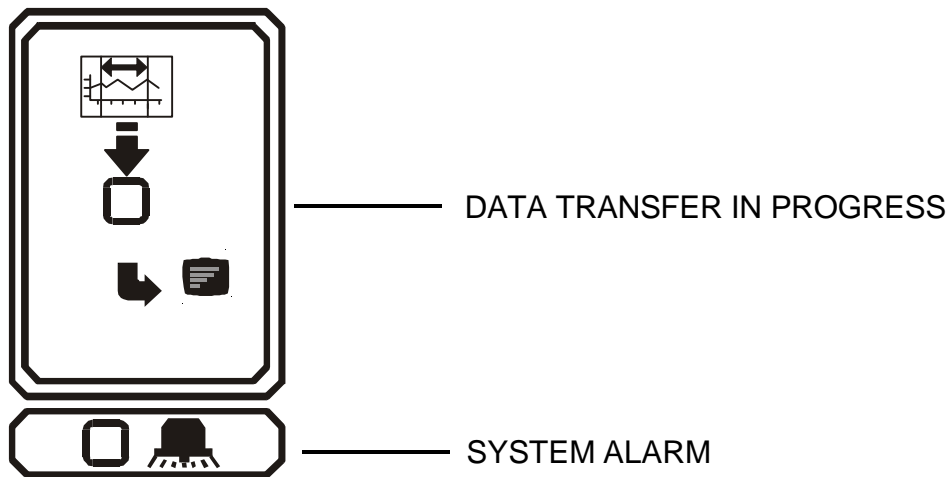

The System Alarm can be triggered by the high temperature alarm, low temperature alarm, or by a sensor fault.

## 3.2 MAIN SCREENS

### 3.2.1 MAIN SCREEN 1: CHANNEL TEMPERATURE DISPLAY

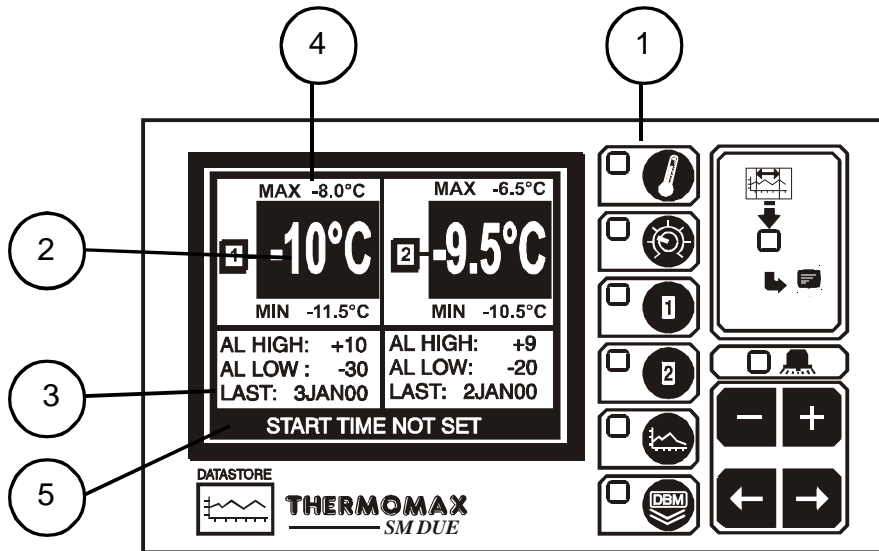

- 1 MAIN SCREEN function selector.
- 2 Two channel digital temperature display, viewed in either °C or °F.
- 3 High and Low Alarm Limits for each channel plus date of last alarm.
- 4 Maximum and minimum daily temperatures for each channel.



**Note:** The display contrast may be adjusted in this screen. Press **+** to increase and **-** to decrease the contrast. To adjust quickly, press and hold for auto-repeat.

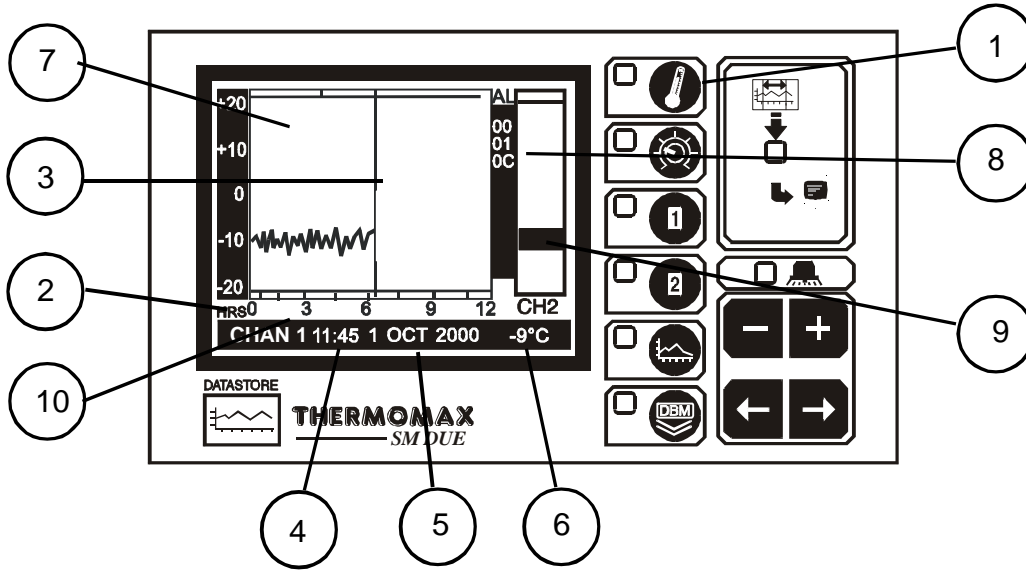

### 3.2.2 MAIN SCREEN 2: CURRENT DAY PLOT SCREEN



#### 1 MAIN SCREEN function selector

Pressing this key a second time displays the plot of the temperatures logged for the current day. When this function has been selected, the current day plot screen for either of the channels may be displayed by pressing the

appropriate channel function selector key:  or .

2 **Time of Day:** This is the horizontal axis scale, and represents time. The required twelve-hour period is selected using the   keys.

3 **Current Time-Bar:** The time-bar indicates the current time of day, and therefore the graph following this time bar will be blank. Samples from earlier in the day may be examined by pressing the  key to move the time-bar to the left. The status of the current time bar is detailed at the bottom of the screen as per 4-6 below.

4 **Plot Time:** This displays in digital form, the time indicated by the time-bar. (The time is displayed in 5-minute sample intervals).

5 **Plot Date:** This shows the date of the currently displayed graph.

6 **Time-Bar Temperature:** This displays the logged temperature at the time indicated by the time-bar. (The time / temperature is displayed in 5 minute sample intervals).

7 **Alarm Log:** Alarm indication to reveal the incidence of an alarm, the time it occurred and its duration.

8 **Unique electronic serial number of SM DUE.**

9 **'Other Channel' Range:** Display of max. and min. temperatures recorded.

10 **This area of the display shows any occurrence of a cold room door opening.**

**Note:** The recorded temperature data is displayed graphically with a 10 minute sample interval.

### 3.3 SET SCREENS

#### 3.3.1 SET SCREEN 1: CLOCK/CALENDAR



#### 1 SET SCREEN function selector

The datalogging system uses the calendar to file the logged data.

#### 2 Selection indicator

The highlighted parameter is adjusted by pressing the **+** or **-** key. (The selections are: 'year', 'month', 'day', '↑', 'hour' and 'minutes'.)

The '↑' indicates that the day on the calendar above is being set.

The clock is in 24-hour format.

To advance quickly, press and hold the **+** or **-** key for auto repeat.

#### 3 Calendar

This is the calendar of the month selected, with day of the week indication.

#### SETTING THE DATE AND TIME:

Step 1: Use the **- +** keys to set the current 'Year'.

Step 2: Use the **→** key to move to the 'Month' option and then use the **- +** keys to set the current month.

Step 3: Repeat step 2 to set the current 'date' and 'time' ('minutes' and 'hours') in turn.

### 3.3.2 SET SCREEN 2: SYSTEM PRESETS

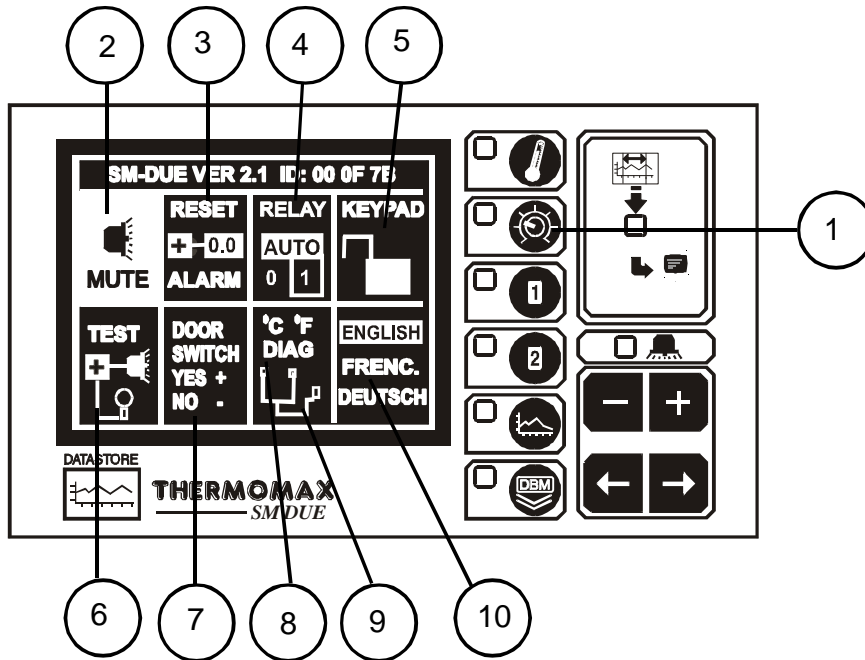

**1 SET SCREEN function selector**

Pressing this key a second time reveals Set Screen 2.



**2 Alarm Mute**

To mute the SM DUE's internal audible alarm, press the  key when the MUTE window is selected. When the alarm system is reset, either manually or by the temperatures dropping within pre-set limits, the alarm mute will be cancelled automatically.

**3 Alarm Reset**

Any current activities, delays or counters are reset by pressing the  key when the RESET window is selected.

**4 Alarm Relay Status**

The output status of the alarm relay may be either viewed or altered by pressing the  or  key when the RELAY window is selected.

- ↙ **0** = Relay Manually disabled (ALARM ON)
- AUTO** = For normal operation:
- ↘ **1** = Relay Manually activated (ALARM OFF)

**5 Keypad Lock**

Refer to page 26 of this manual.

## 6 Piezo and Indicator test

By pressing the **+** key when the TEST window is selected, the **SM DUE's** internal audible alarm will 'sound' and all indicators will illuminate. This allows the user to ensure both are functional.

## 7 Door Switch Selection.

The SM DUE provides the option to connect a door switch for monitoring purposes, the status of the door is displayed and logged in graphical form (see section 3.2.2). This option may be enabled or disabled by pressing the **+** or **-** key respectively. The diagram in section 2.4 shows how to connect a door switch.

## 8 Temperature Scale.

The scale used by the system to communicate the temperature information may be selected here. Press **+** for °C and **-** for °F.

## 9 Diagnostics.

By pressing the **+** key when the DIAG window is selected, the **SM DUE** DIAGNOSTICS screen is activated. (see next section 3.4).

## 10 Language Selection

The language used by the system to communicate the information may be selected here. Choose the **+** and **-** keys to make your English, French or German Language selection.

### 3.3.3 SET SCREEN 3: SYSTEM PRESETS 2

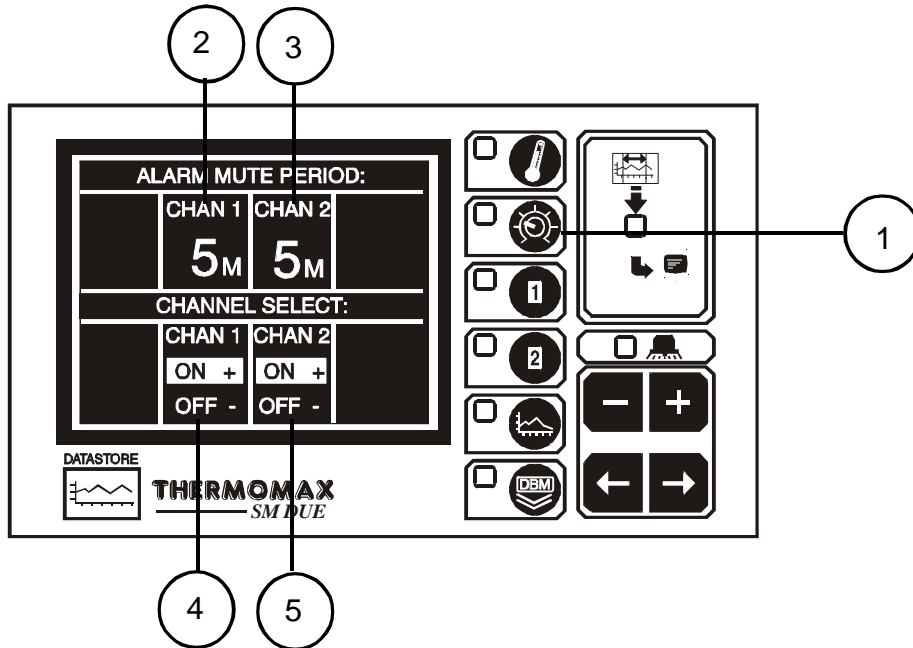

- 1 SET SCREEN function selector  
Pressing this key a third time reveals Set Screen 3.
- 2 Alarm Mute Period for Channel 1 (from 0 to 95 minutes). If any key is pressed during an Alarm situation for this channel, the buzzer will be muted (silenced) for this period.
- 3 Alarm Mute Period for Channel 2 (from 0 to 95 minutes). Same as above.
- 4 Channel Select for Channel 1. Each sensor input can be “switched” on or off by pressing the **+** or **-** keys for 5 seconds respectively. When the sensor input is switched “ON”, the unit will operate in normal mode and the actual sensor temperature will be monitored and logged to the databank every 5 minutes. If the sensor input is switched “OFF”, the unit will display 0°C continuously. This value will also be logged to the databank. Hence it is therefore only necessary to connect sensors to the required number of inputs.

**NOTE:**

If a channel is switched off, the alarm parameters will automatically revert back to the default factory settings to prevent an alarm occurrence. These parameters cannot be changed until the sensor input is switched on again.

- 5 Channel Select for Channel 2.

### 3.4 SYSTEM DIAGNOSTICS

#### 3.4.1 DATABANK DIAGNOSTICS SCREEN

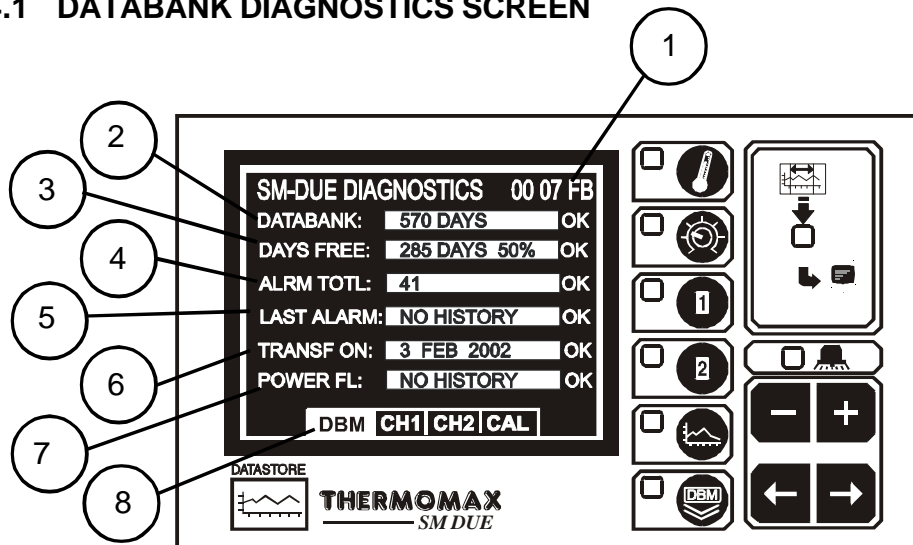

- 1 This is the unique electronic signature of the SM DUE.
- 2 The DATABANK window shows the capacity of the internal databank. There are two SM DUE options available:
  - (a) Recording frequency 5 minutes – Databank capacity 570 days  
(approx. 1 ½ years - factory default)
  - (b) Recording frequency 10 minutes – Databank capacity 1128 days  
(approx. 3 years)
- 3 The DAYS LEFT window shows the total number of days, and also the total percentage of the databank, which have not yet been 'used'.
- 4 The ALRM TOTL window shows the total number of alarm incidences which have occurred in the current year.
- 5 The LAST ALRM window shows the last date on which an alarm condition occurred.
- 6 The TRANSF ON window shows the date on which the contents of the internal databank need to be transferred.
- 7 The POWER FL window shows the last date on which the power failed. During a power fail situation this window will display the duration, in minutes, of the power failure.
- 8 Diagnostics Screen Selection.  
Use the **←** **→** keys to move between one of four diagnostic screens:
  - DBM: Databank Diagnostics Screen (Ref. 3.4.1 above)
  - CH1: Channel 1 Diagnostics Screen (Ref. 3.4.2)
  - CH2: Channel 2 Diagnostics Screen (Ref. 3.4.2)
  - CAL: Calibration Trimming Screen (Ref. 3.4.3)



### 3.4.3 CALIBRATION TRIMMING SCREEN

Calibration trimming allows qualified personnel to adjust the SM DUE's calibration by  $\pm 2^{\circ}\text{C}$ .

**Note:** A known reference temperature should be used.

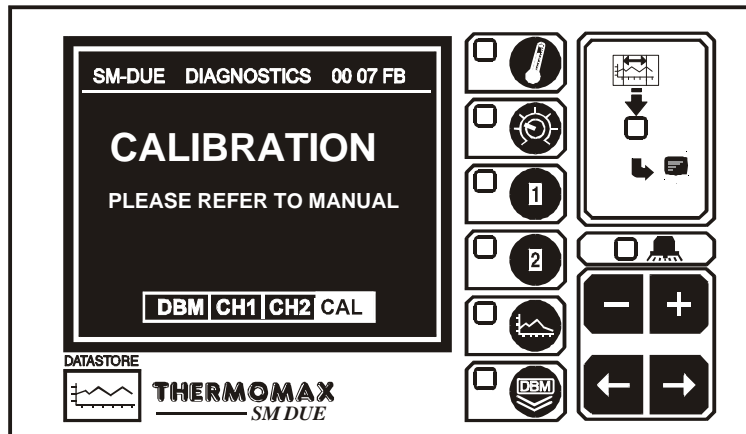

To enter the CALIBRATION TRIMMING Screen, press and hold the **+** key for 5 seconds.

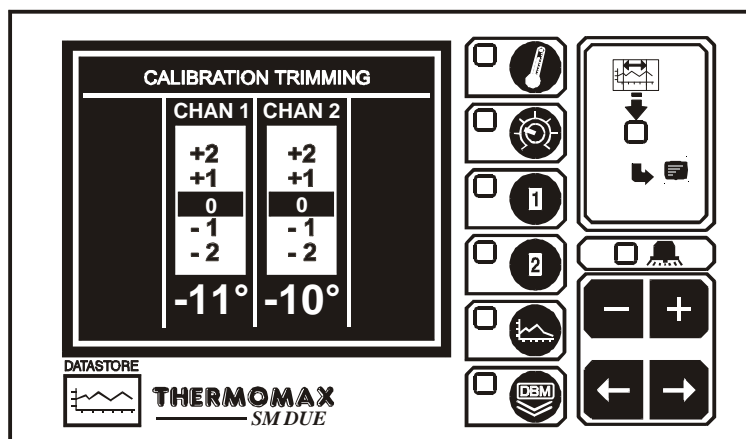

Use the **←** **→** keys to move to the channel that requires calibration trimming. Then use the **+** or **-** keys to adjust the current temperature reading.

### 3.5 CHANNEL SCREENS

#### 3.5.1 CHANNEL DISPLAY SCREENS

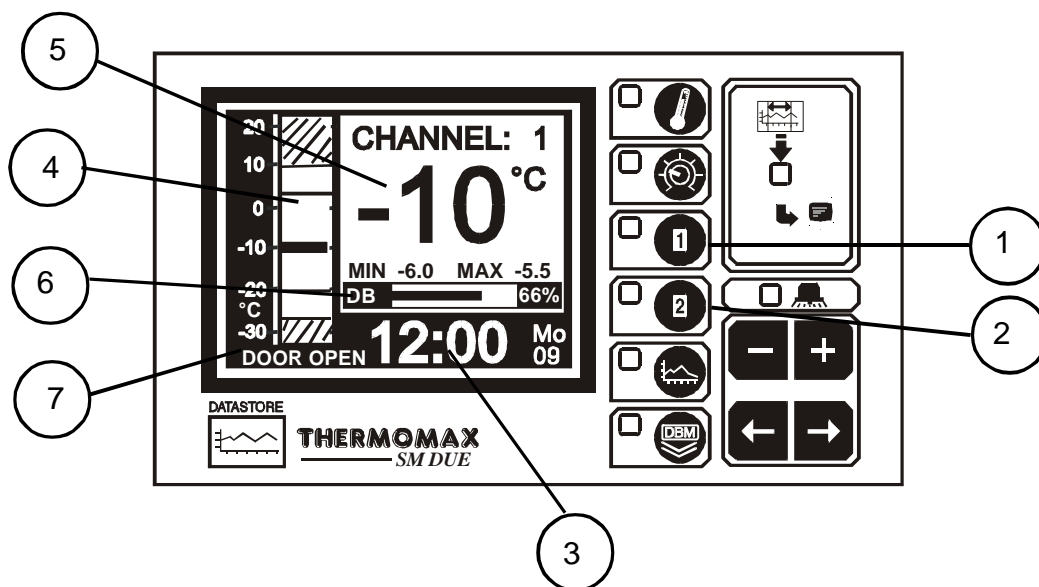

- 1 CHANNEL 1 function selector: displays the information for channel 1.
- 2 CHANNEL 2 function selector: displays the information for channel 2.
- 3 Clock display: 24-hour format with day of week abbreviation.
- 4 Temperature bargraph: High and low alarm limits are shown as shaded areas. The two horizontal 'lines' represent the maximum and minimum, high and low temperature alarms respectively.
- 5 Digital display of Channel temperature, with minimum / maximum indication. The minimum and maximum values are daily values, and are reset at midnight.
- 6 Internal databank indicator: This indicates the percentage 'used', in both bargraph and digital form.
- 7 When the door switch facility is activated (see 3.3.2), this area will show the status of the door as 'door open' or 'door closed'. Note that if there is no switch connected, the unit will display 'door open'.

**Note:** The display contrast may also be adjusted from any of these screens by pressing the **+** or **-** keys.

### 3.5.2 CHANNEL SET SCREENS

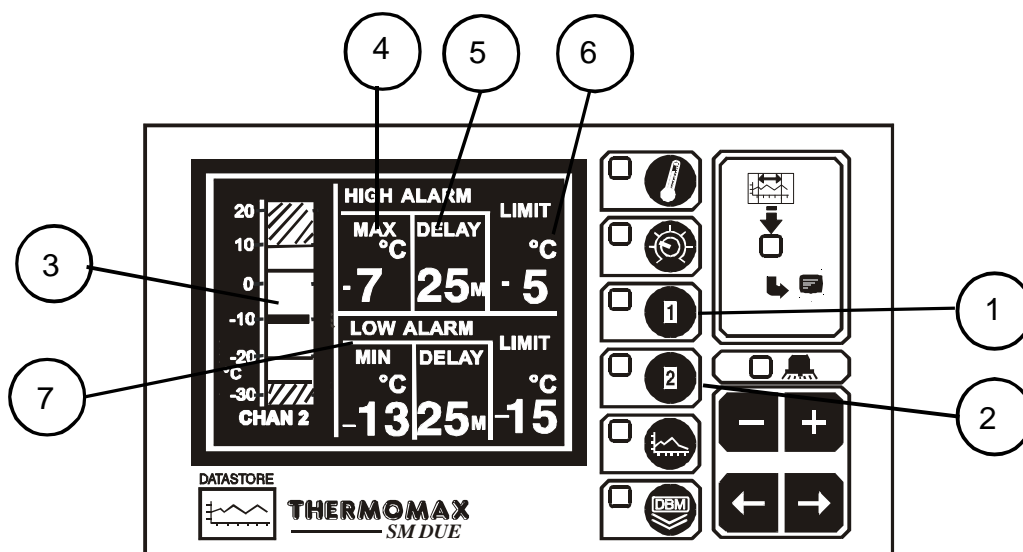

**1 Channel 1 function selector**

**2 Channel 2 function selector**

Pressing either of these keys a second time will display the “Channel Set Screen” for the appropriate channel.

**3 Bargraph Display Scale**

By pressing the **+** or **-** key, the bargraph display scale may be adjusted to show the temperature range best suited to the particular installation. This scale is also used for the “Plot display” (Ref. 3.2.2 Current Day Plot and 3.6 Plot History).

**4 High Alarm Stage 1 temperature (-50°C to +50°C)**

The Stage 1 alarm is a time/temperature-related alarm. If the maximum threshold is exceeded, a timer is initiated, and no further action is taken at this time.

**5 High Alarm Stage 1 Delay (1 - 99 min.)**

After the maximum threshold has been exceeded (Ref. 4 above), the alarm will not be triggered until the timer exceeds the time delay set here. If the temperature drops below the threshold before the expiry of this delay, the timer is reset. If following this the temperature rises above the threshold again, the timer restarts from zero.

**6 High Alarm Limit Stage 2 temperature (-50°C to +50°C)**

If at any time this limit is exceeded the time delays will be overridden and the alarm will trigger immediately.

**7 Low Alarm**

All the functions described in 4-6 above also apply to the low alarm.

### 3.6 PLOT HISTORY

#### 3.6.1 DATA LOG OF PREVIOUS DAYS

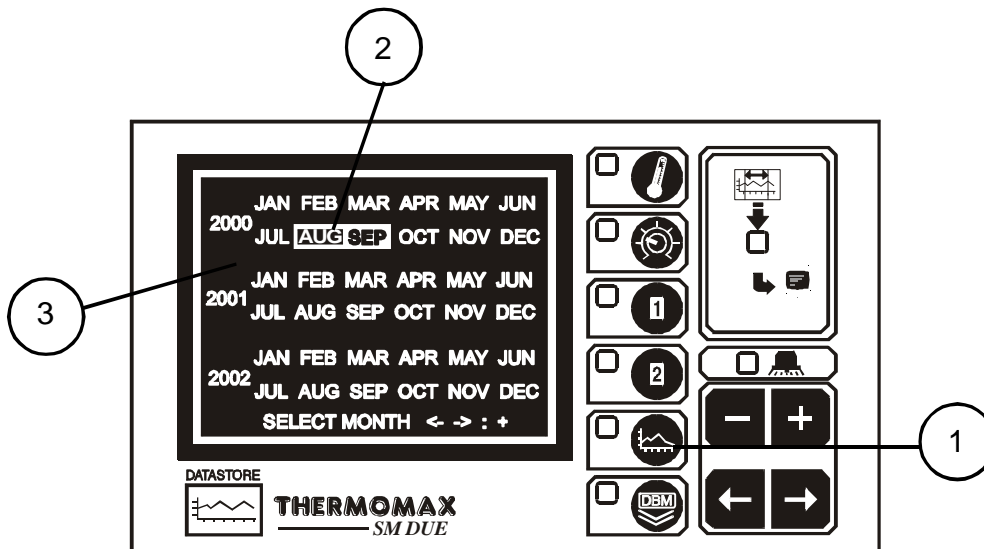

#### 1 Plot History function selector

When this key is pressed, the directory of the contents of the internal databank is displayed, as above.

2 The highlighted months on this screen are the months for which the databank contains data.

#### 3 Current Selection

To view the plot of a particular day, select the required month from the calendar using the keys, followed by the key to accept the selection. A second screen appears for the selection of the day, after which the logged data for the required day is displayed for inspection.

(Ref. Section 3.2.2 MAIN SCREEN 2: Current Day Plot Screen)

When the required plot is displayed, the plot screen for either of the channels

may be viewed by pressing the appropriate channel function key: or

.

To exit the Plot History function, press the main key .

### 3.7 DATA TRANSFER

The SM DUE is supplied with an internal reusable 1 ½ year databank. The contents of this databank may be transferred directly to the PC using the MASTERLINK Software or, alternatively, the MASTERLINK Hardware may be used as an intermediate storage device to transfer data to a PC at a remote location.

#### 3.7.1 Transferring Data Using the Masterlink software

**NOTE: Before data can be transferred to the PC, the software must be set up on the PC, as per the MASTERLINK Software Manual.**

- (a) Plug the 8 Way SX plug of the 'PC Cable Assembly' into the SERIAL LINK of the SM DUE.
- (b) Then plug the 9 Way 'female D type' connector into any free serial port in the PC.

**NOTE: For Panelmount units, read section 3.8 before attempting to download or print data.**

#### 3.7.2 Transferring Data to the Masterlink Hardware

- (a) Connect the 'MASTERLINK Cable Assembly', from the SERIAL LINK SX socket of the SM DUE to the MASTERLINK Hardware.
- (b) Press the  key to reveal the following screen:

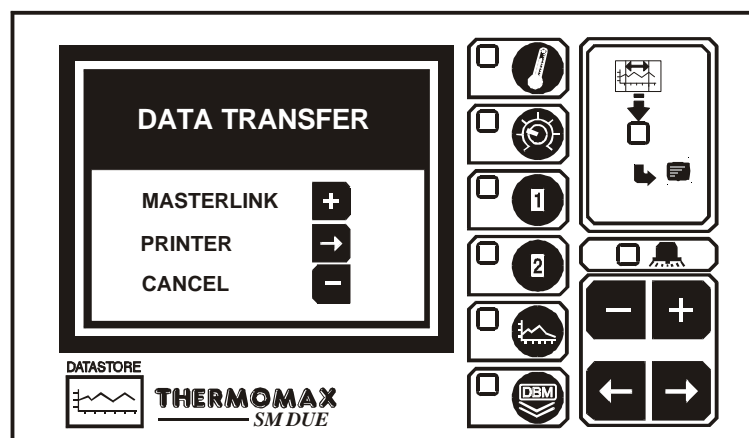

- (c) To download data to the Masterlink Hardware unit, (Part No. C0321), press the  key and the following screen will appear:

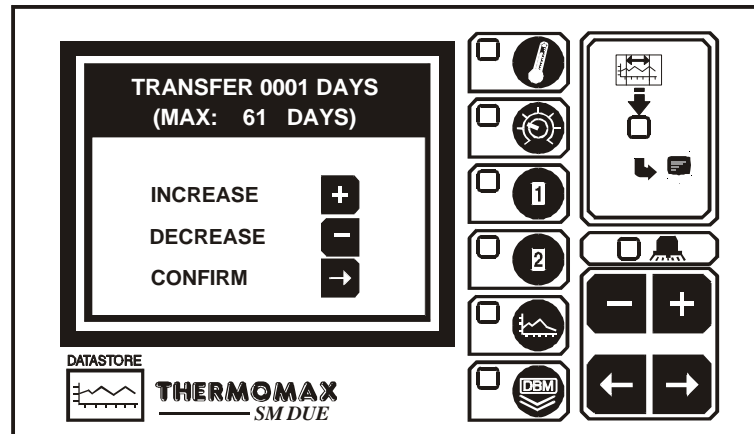

- (d) The user can now choose any number of days, (starting from the current day), to transfer to the Masterlink Hardware – from 1 day up to the total number of days stored in the internal databank of the Thermomax unit. In this example, there are 61 days of data stored in the Databank.
- (e) To increase or decrease the number of days to download, press the **+** or **-** key and then press the **→** key to confirm this. The maximum number of days the user will be able to download, corresponds to the number of days data stored in the databank.

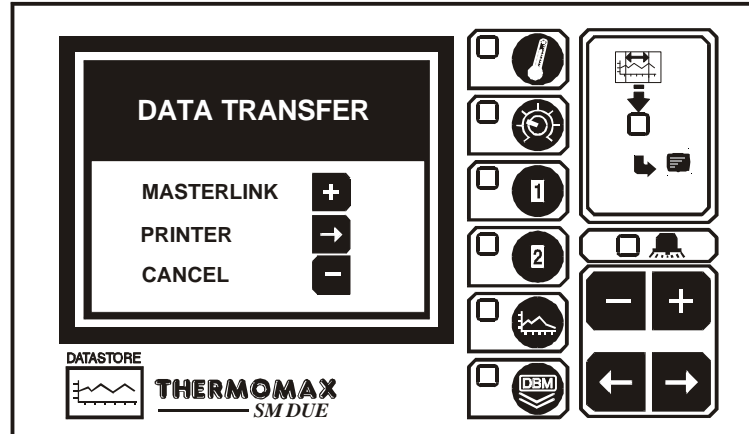

### 3.7.3 Printing Data to the Thermomax Serial Printer

- (a) Press the  key to reveal the following screen:

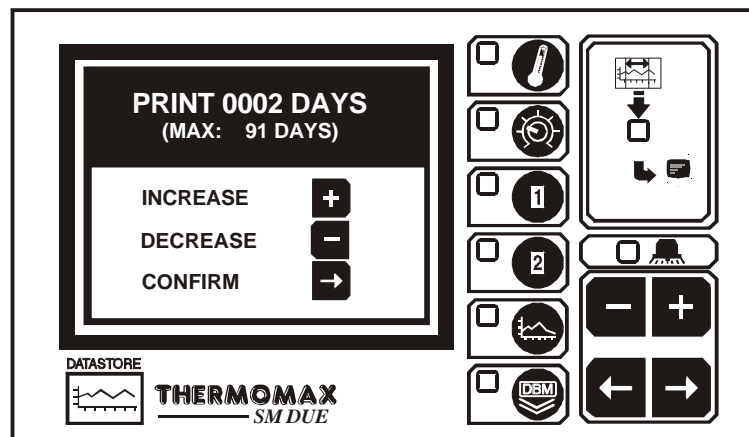

- (b) To print data directly to the serial printer, (Part No. A6747), press the  key and the following screen will appear:



- (c) The user can now choose any number of days, (starting from the current day), to print directly to the Thermomax serial Printer – from 1 day up to the total number of days stored in the internal databank of the Thermomax unit. In this example, there are 61 days of data stored in the Databank.
- (d) To increase or decrease the number of days to print, press the  or  key and then press the  key to confirm this.

### 3.8 DATA TRANSFER - PANELMOUNT UNITS ONLY

The following functions / features have been added to the new Panelmount units.

Mode 1 In Standard Mode the serial socket can be used for the following functions:

- Direct connection to PC
- Direct connection to Masterlink Hardware
- Direct connection to Thermomax Serial Printer

The unit is despatched from Thermomax in this mode.

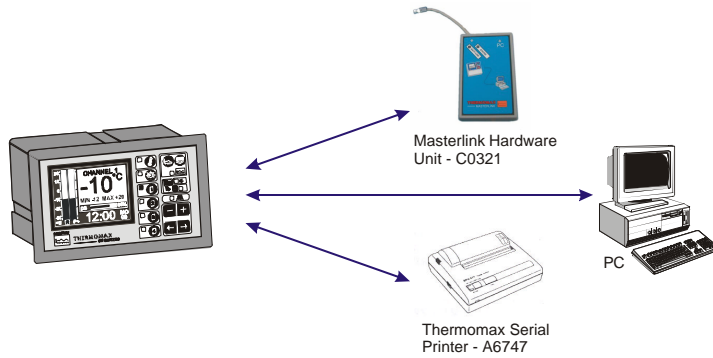

Mode 2 This mode is used to network up to 32 units to one PC, (see illustration below).

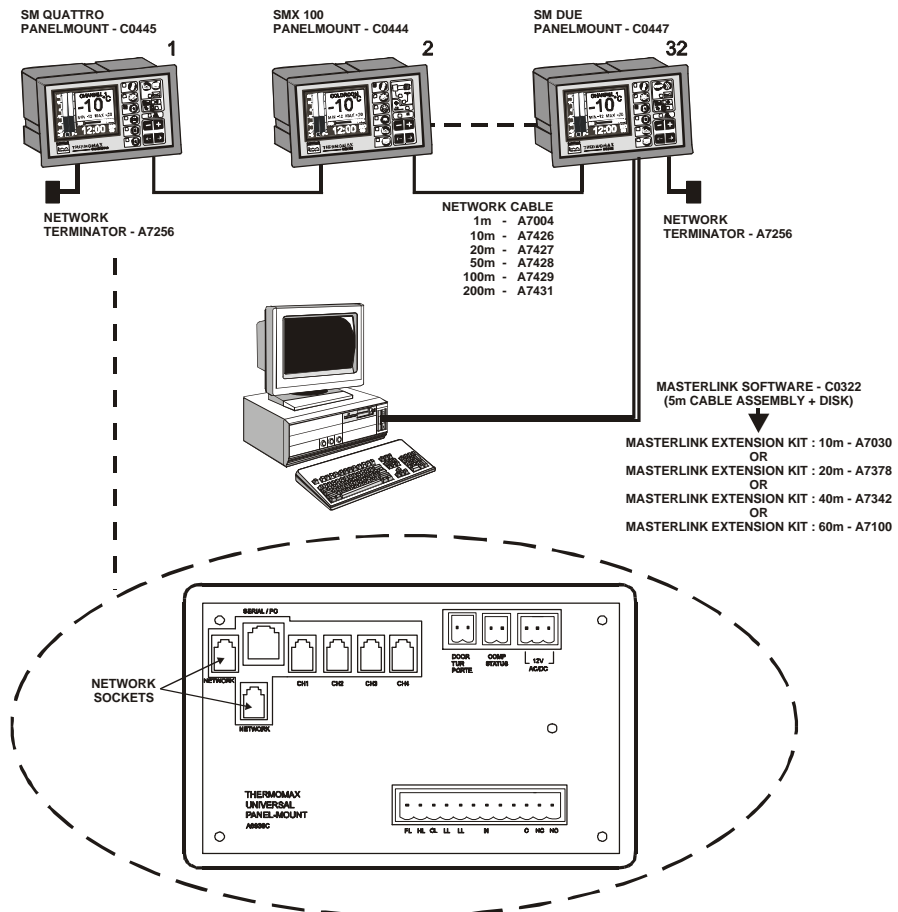

**MODE 1 – STANDARD MODE (DISABLING NETWORK MODE)**

If the network is enabled and the user tries to download data to the Masterlink Hardware or print directly to the Thermomax Serial Printer, the following screen will appear.

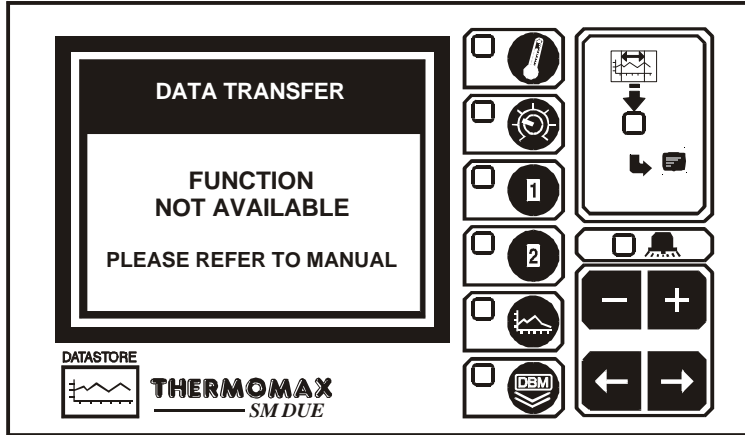

In order to download data to the Masterlink Hardware unit or print directly to a Thermomax Serial Printer, the network must be disabled.

To disable network, press the  key twice to reveal the following screen:

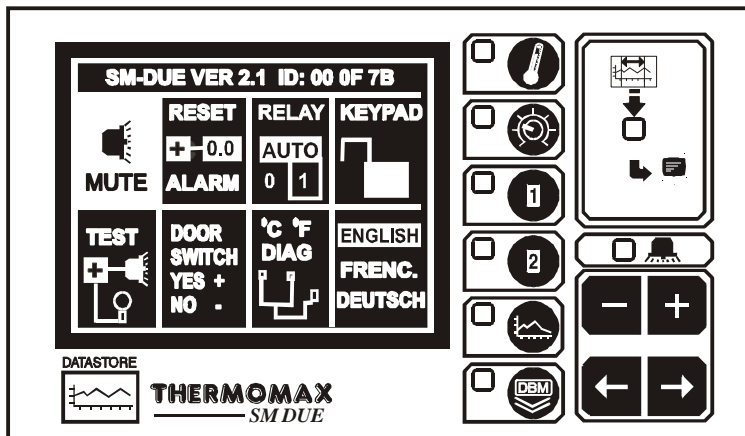

Select the  window by using the  key and press the  key to show the following screen:

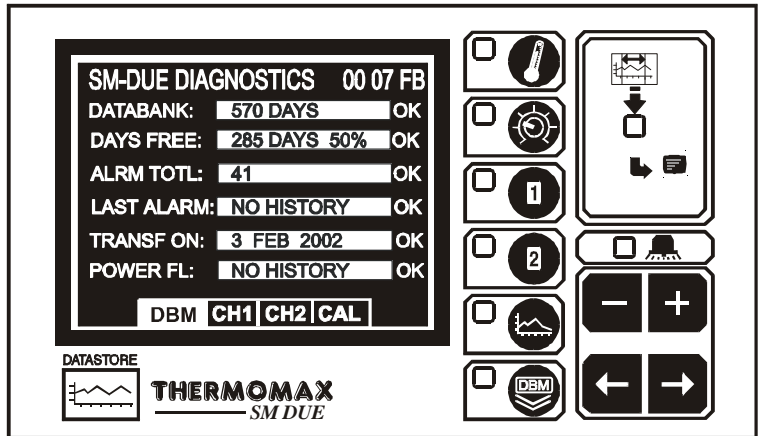

With this screen displayed, press and hold the **-** key for approximately 10 seconds. The following screen will appear:

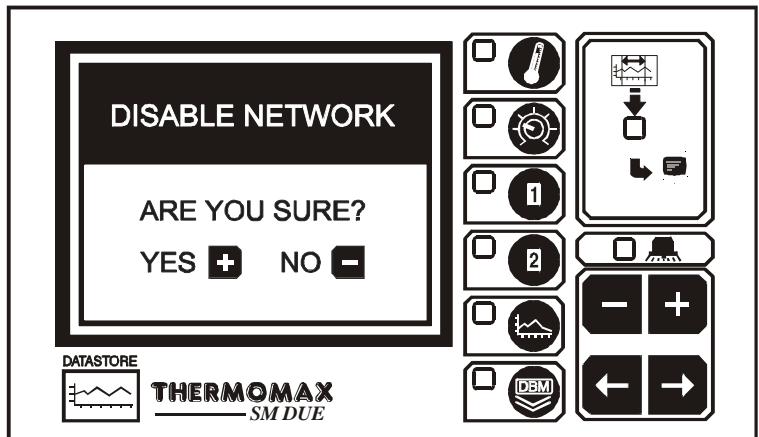



To disable the network press the **+** key. (When the **+** key is pressed, the SM Due will switch off and back on again).

If you do not wish to disable the network, press the **-** key.

## MODE 2 – NETWORK MODE (SELECTING NETWORK MODE)

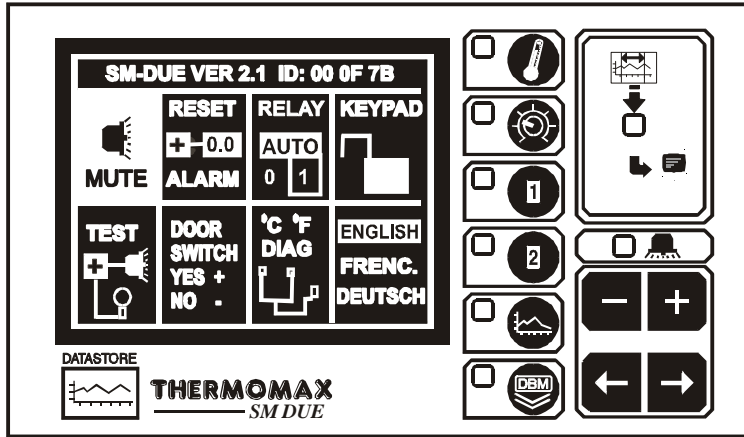
To select the network mode, press the  key twice to reveal the following screen:



Select the  window by using the  key and press the  key to show the following screen:

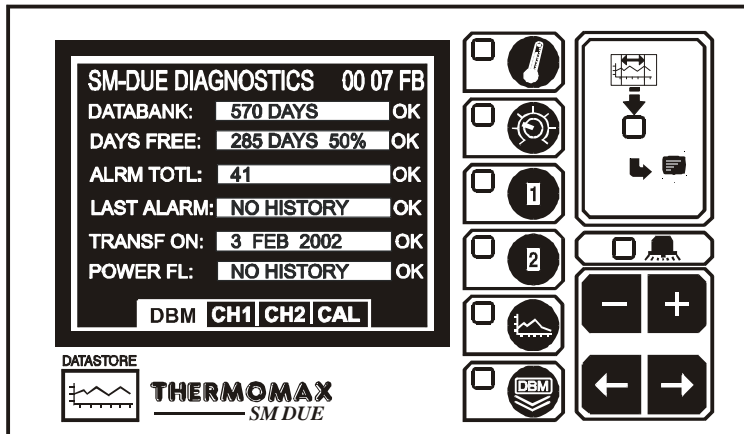

With this screen displayed, press and hold the  key for approximately 10 seconds. The following screen will appear:

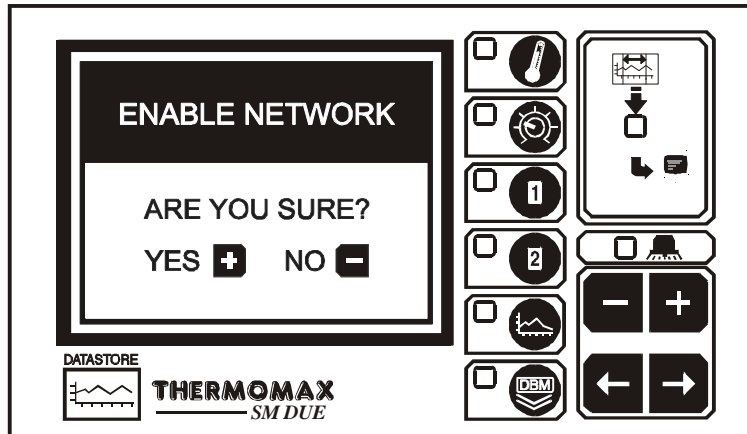

To enable the network press the **+** key. (When the **+** key is pressed, the SM Due will switch off and back on again).

If you do not wish to enable the network, press the **-** key.

## SECTION 4 FAULT FINDING

- Problem:** Nothing happens when the unit is powered-up.  
**Cause / Remedy:** One of the fuses could be blown - check and replace if necessary (refer to specifications for values). If the fuses blow again, contact the agent where the unit was purchased.
- Problem:** The temperature display is fluctuating.  
**Cause / Remedy:** One of the sensor connections may be loose, or a sensor cable may be too close to a mains cable. Tighten connections and re-route cables if necessary.
- Problem:** Unable to set any of the parameters: Keypad will not operate.  
**Cause / Remedy:** The Keypad Lock is on - See 'Keypad Lock'.
- Problem:** The display screen is too dark or too faint.  
**Cause / Remedy:** Adjust the display contrast to suit - See 'Display Contrast' in the MAIN SCREEN 1 section.
- Problem:** The System Alarm light is flashing once every 3 seconds.  
**Cause / Remedy:** This indicates a system warning. Check the 'CHANNEL DIAGNOSTICS' screens for indication of the specific warning.
- Problem:** The System Alarm light is flashing and the audible sounder is active.  
**Cause / Remedy:** This indicates a system fault or temperature alarm. Check the 'CHANNEL DIAGNOSTICS' screens for indication of the specific alarm (Page 14).

## SECTION5 SPECIFICATIONS

### ELECTRICAL:

<b>Supply Voltage:</b>	220-240V AC Single Phase / 24V DC or 12V DC
<b>Ambient Temperature:</b>	0°C to +40°C
<b>Fuses:</b>	2 X 1A 20mm Quick Blow
<b>Alarm Relay Output:</b>	5A changeover 3 pin isolated - (volt-free contacts) May be used for low or mains voltage

### MECHANICAL:

<b>Dimensions:</b>	width: 165mm
	height: 160mm
	depth: 75mm
	weight: <b>SM DUE</b> Unit: 0.96Kg
	Sensor: (each) 0.13Kg
<b>Box Material:</b>	Plastic
<b>Front Panel:</b>	Reverse printed
<b>Display:</b>	Large LCD supertwist graphics
<b>SENSORS:</b>	
<b>Type:</b>	SX™ PT 100 Platinum Film
<b>Compensation:</b>	3 wire compensated
<b>Battery:</b>	9V PP3 Rechargeable
<b>DATABANK CAPACITY:</b>	
<b>Recording Frequency of 5 minutes</b>	570 days
<b>Recording Frequency of 10 minutes</b>	1128 days

## PARTS LIST

SM DUE Unit (24V)	C0403
SM DUE Unit (12V)	C0419
Sensor (5m cable)	A6905
Sensor (15m cable)	A6915
Sensor (25m cable)	A6925
Sensor (50m cable)	A6950
Sensor (100m cable)	A7999

## ACCESSORIES

Sensor Extender 10m	A6911	Serial Printer	A6747
Sensor Extender 20m	A6921	Serial Printer Cable	A7433
Sensor Extender 50m	A6951	Network Terminators	A7256
MASTERLINK Software	C0322		
MASTERLINK Hardware	C0321		
Network Connecting Cable : 1m (Ivory)		A7004	
Network Connecting Cable : 10m (Ivory)		A7426	
Network Connecting Cable : 20m (Ivory)		A7427	
Network Connecting Cable : 50m (Ivory)		A7428	
Network Connecting Cable : 100m (Ivory)		A7429	
Network Connecting Cable : 200m (Ivory)		A7431	
Masterlink Software Extension Kit : 10m (Ivory)		A7030	
Masterlink Software Extension Kit : 20m (Ivory)		A7378	
Masterlink Software Extension Kit : 40m (Ivory)		A7342	
Masterlink Software Extension Kit : 60m (Ivory)		A7100	



## KEYPAD LOCK

The keypad may be locked or unlocked when this window is selected.

To lock, press the  key and hold for 5 seconds.

To unlock, press the  key and hold for 5 seconds.

When the keypad is locked, the SM DUE enters into a security mode, which renders the unit 'tamper-proof'.

There are three functions for which the set keys ( / ) will operate when the keypad is locked.

- (a) Display contrast (see 3.2.1 MAIN SCREEN 1);
- (b) Alarm mute and reset (see 3.3.2 System Pre-sets);
- (c) Entering the Diagnostics Screen for viewing (see section 3.4).

# CE

This product has been tested to the EU EMC 89/336/EEC directive according to the Manufacturer's report, which is available on request.

This product is in conformance with the Low Voltage Directive 73/23/EEC.

Thermomax certifies that this datalogging and / or control device has been manufactured to an ISO 9002 Quality System.

Thermomax undertakes to repair or replace the device if same is shown to be defective in its manufacture and / or components, but Thermomax shall not be responsible for any other financial or economic loss (or any indirect loss) which may be incurred by the buyer / customer or others in the use of the device.

Any claim for repair or replacement must be made not later than 15 months after the date of manufacture.

# SM DUE PANELMOUNT

## DIMENSIONAL DETAILS

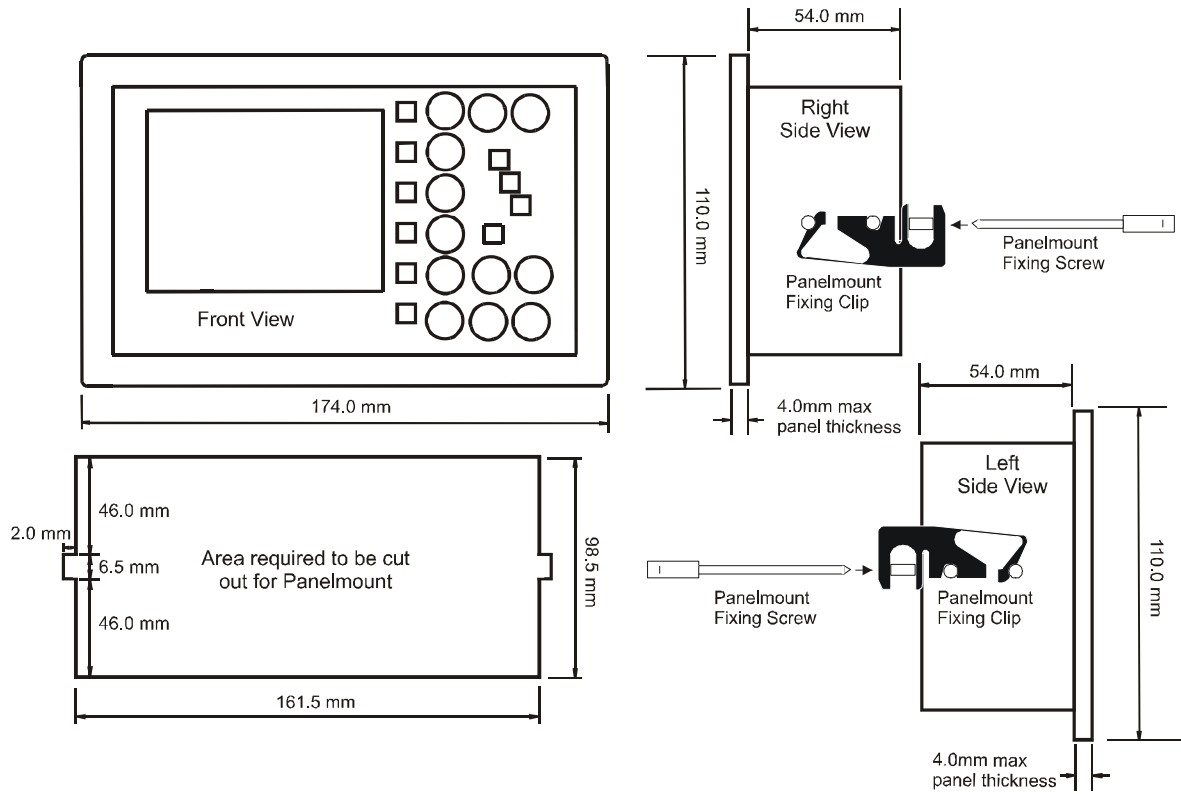

After inserting the Panelmount unit into the panel cut out, attach the two panelmount fixing clips (supplied), to the two studs at either side of the unit, (as above). The Panelmount unit is then held in place by the two Panelmount fixing screws (also supplied).

# WIRING DIAGRAM

**NOTE:**  
 For SM DUE applications:  
 CH1 = CH1  
 CH2 = CH2

